

SECTION B-B

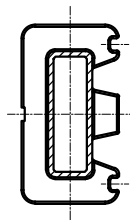

SECTION C-C

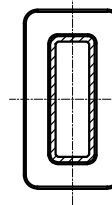

SECTION C-C

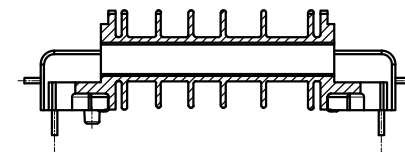
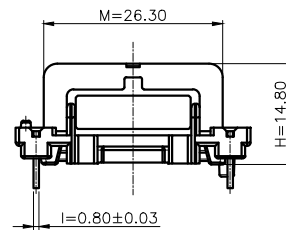
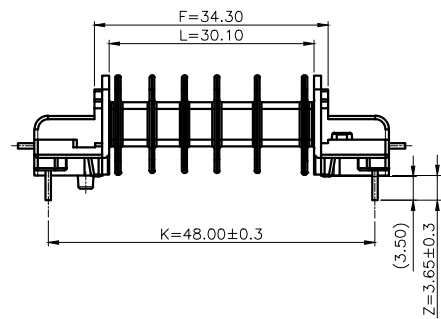
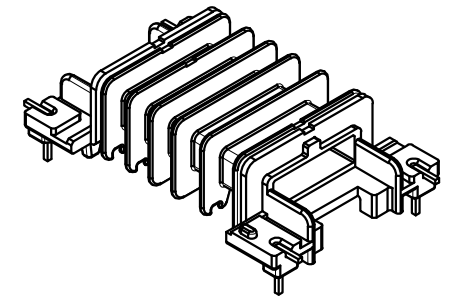

SECTION A-A

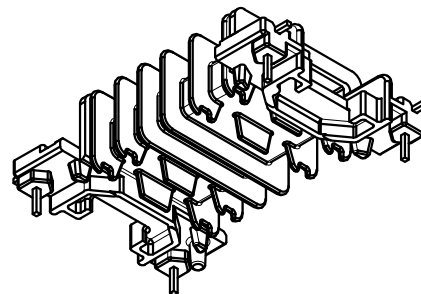
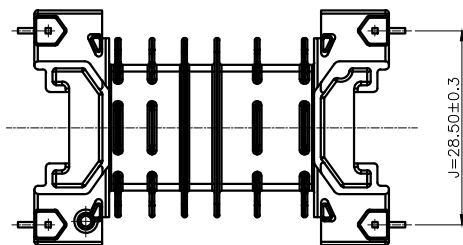

▲							
▲							
▲							
▲							
MARK	REVISION NOTE			DATE	DRAWN	CHECKED	APPROVED
DRAWN	CHECKED	APPROVED	MATERIAL : P.E.T (BK)	UL REC. : UL94V-0	THIRD ANGLE PROJ.	SCALE : 1/1	
B M, Won	D B, Han	J B, Lim	Y, Z : PIN LENGTH (According to customer's request)	DATE : 2011.10.20	TOLERANCE : ±0.2 (Unless otherwise specified)	UNIT : m/m	
주식회사 대흥보빈 DAE HEUNG BOBBIN CO., LTD			TITLE UU 16*45 H (4P) (A)		DWG NO DH-111117-1024-00		